

**DRILLING PLANS FOR "OPENING WITH HANDLE"**

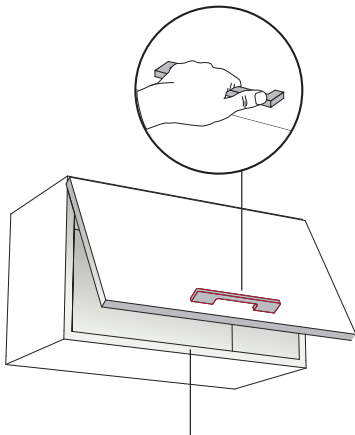

\* Magnetic catch - K Lock

**Sprung hinges**

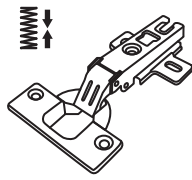

**Unsprung hinges**

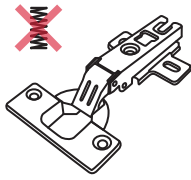

\* Magnetic catch - K Lock

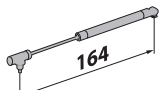
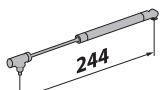
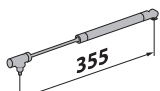
L	A	B	C	D
	39	37	158	180
	76	37	230	250
	127	37	330	350

**KIMANA hinges**

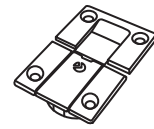

By using the KIMANA hinge on a lift-up door two lid stays are strongly recommended.

\* Magnetic catch - K Lock

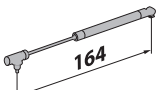
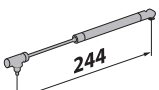
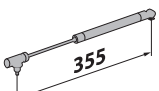
L	A	B	C	D
	39	37	156	170
	76	37	228	245
	127	37	328	345

**DRILLING PLANS FOR "PUSH TO OPEN"**

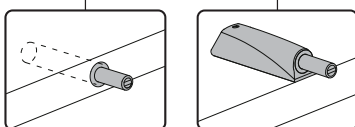
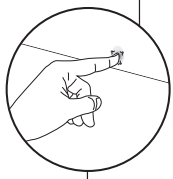
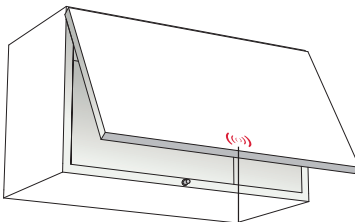

K Push Tech

**Sprung hinges**

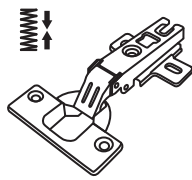

K Push Tech with buffer

**Unsprung hinges**

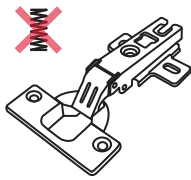

K Push Tech with magnet

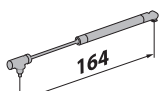
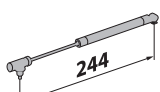
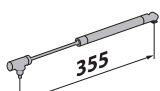

L	A	B	C	D
	41	52	147	170
	71	52	224	245
	121	52	325	345

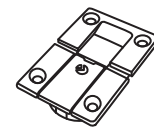
**KIMANA hinges**

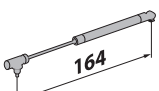

By using the KIMANA hinge on a lift-up door two lid stays are strongly recommended.

K Push Tech with magnet

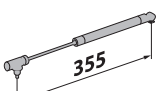
L	A	B	C	D
	41	52	145	160
	71	52	222	240
	121	52	323	340