

Kidney Lazy Susan 28 in Dia. Maple/Champagne

Part Number: 041-VGLQ734-VCH

Vibo Galaxy Kidney Shape Lazy Susan, 28 in, Maple / Champagne

Kit consists of 2 baskets featuring single elliptical rail with anti-slip melamine bottom. Fast block fittings included but Adjustable Post sold separately.

Application Type	Lazy Susan
Basket Bottom Colour	Maple
Basket Bottom Type	Anti-Slip Melamine
Basket Wire Finish	Champagne
Diameter	715 mm (28-1/8 in)
Finish	Maple / Champagne
Frame Finish	Chrome

Product Description

From Vibo's Galaxy Collection comes the kidney (three-quarter) shaped Lazy Susan which is subtly attractive, durable, and easy to clean. Available in both in the new Anthracite Grey finish and the White/Chrome and Maple/Champagne finishes. Height adjustable shelves are easy to install with "fast block fittings".

Product Advantages

- Available for 2 diameters: 28 or 32 inches
- Premium elliptical wire and anti-slip coated melamine bottoms
- Load capacity on 28" per shelf: 13kg (29lbs)
- Load capacity on 32" per shelf: 16kg (35lbs)



Technical Documents

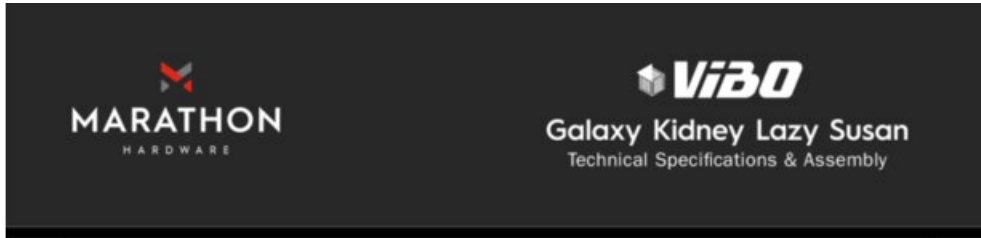

Galaxy Kidney Lazy Susan



Product Features

From Vibo's Galaxy Collection comes the kidney (three-quarter) shaped Lazy Susan which is subtly attractive, durable, and easy to clean. Available in Anthracite Dark Grey finish and the White/Chrome and Maple/Champagne finishes. Height adjustable shelves are easy to install with "fast block fittings".

- Ideal for 45 degree corner cabinets
- Available in 450, 715 and 815mm (18", 28" and 32")
- Anti-slip melamine bottom which is TSCA Title VI compliant
- Load Capacity: 17kg (37lbs) per shelf for 18" & 28" size 21kg (46lbs) per shelf for 32" size

Adjustable Height Metal Post, Chrome

Description	Part#
645 - 720mm (25 1/4" - 28 1/4")	041-VSGTB5002C

Baskets set of 2 including Fast-Block fittings

Description	Finish	Part#
⊙ x H 715 x 645 - 720mm (28 1/4" x 25 1/4" - 28 1/4")	Anthracite Dark Grey	041-VGLQ734-AG
⊙ x H 715 x 645 - 720mm (28 1/4" x 25 1/4" - 28 1/4")	White & Chrome	041-VGLQ734-WHC
⊙ x H 715 x 645 - 720mm (28 1/4" x 25 1/4" - 28 1/4")	Champagne/Maple	041-VGLQ734-VCH
⊙ x H 715 x 645 - 720mm (28 1/4" x 25 1/4" - 28 1/4")	Chrome	041-VGLQ734-C
⊙ x H 815 x 645 - 720mm (32 1/4" x 25 1/4" - 28 1/4")	Anthracite Dark Grey	041-VGLQ834-AG
⊙ x H 815 x 645 - 720mm (32 1/4" x 25 1/4" - 28 1/4")	White & Chrome	041-VGLQ834-WHC
⊙ x H 815 x 645 - 720mm (32 1/4" x 25 1/4" - 28 1/4")	Champagne/Maple	041-VGLQ834-VCH
⊙ x H 815 x 645 - 720mm (32 1/4" x 25 1/4" - 28 1/4")	Chrome	041-VGLQ834-C

Minimum Interior Cabinet Dimensions

- ⊙ x H 715 x 645 - 720mm (28 1/4" x 25 1/4" - 28 1/4")
- ⊙ x H 815 x 645 - 720mm (32 1/4" x 25 1/4" - 28 1/4")

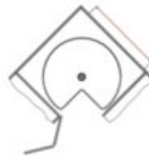

800.840.1228 / MARATHONHARDWARE.COM

View this product online at <https://marathonhardware.com/pd/041-VGLQ734-VCH>



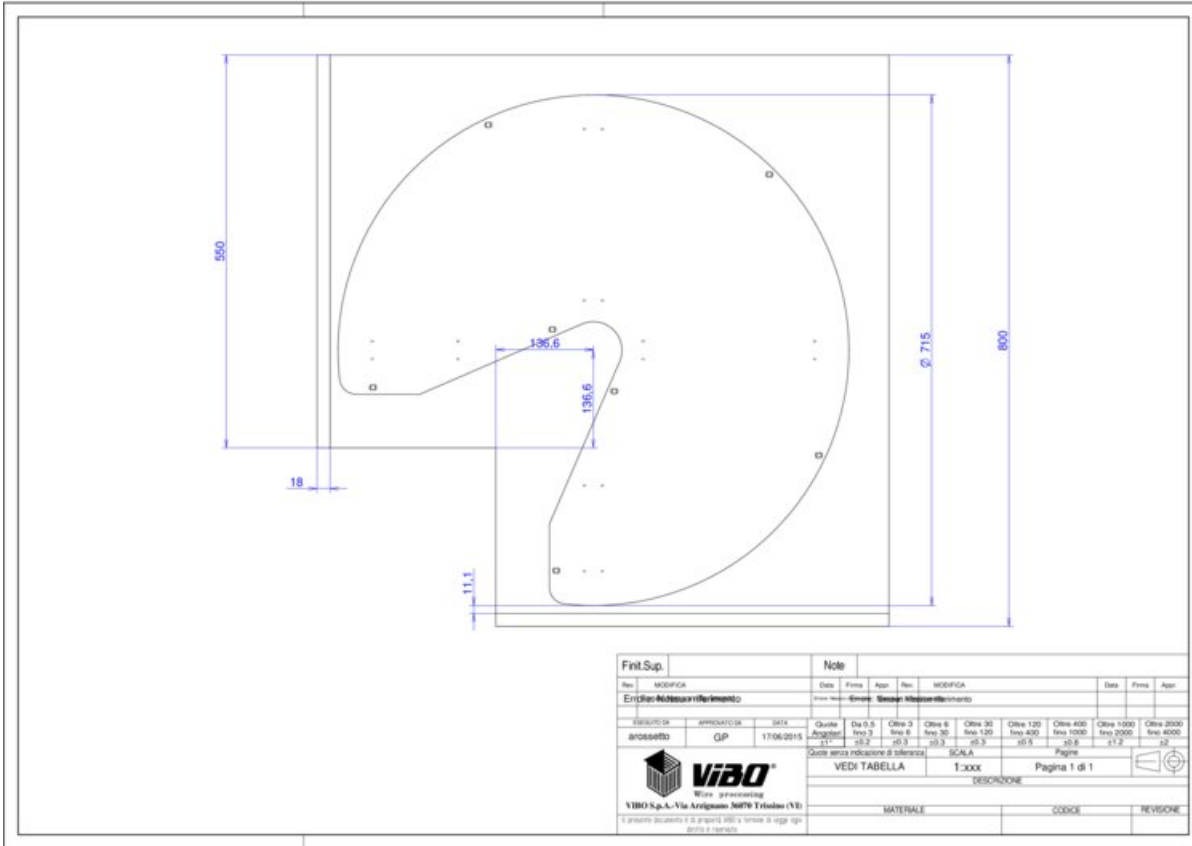





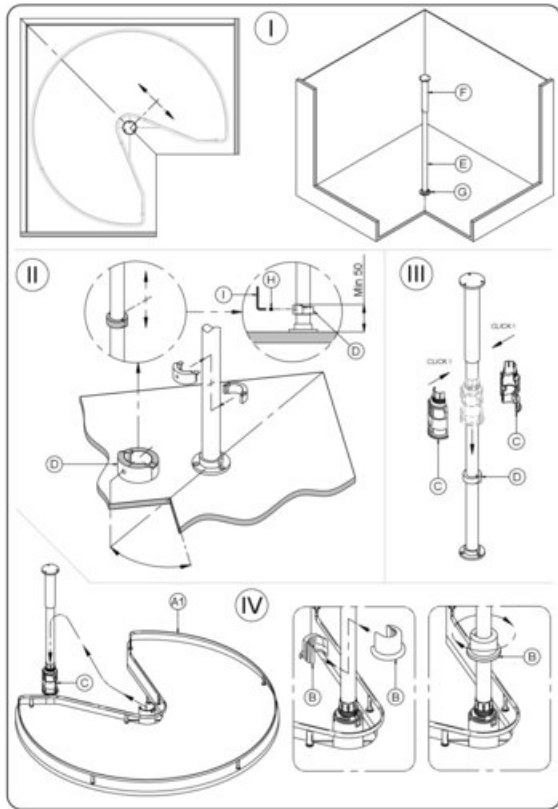





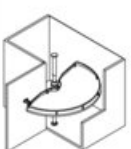



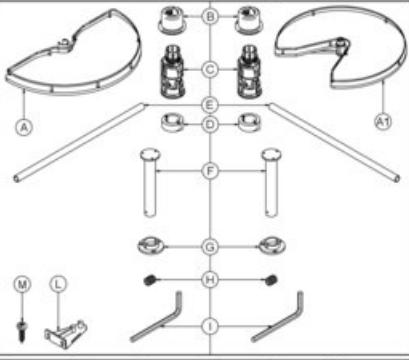

Technical Documents



View this product online at <https://marathonhardware.com/pd/041-VGLQ734-VCH>

Technical Documents



	Portata massima per centro Maximum load per handle Charge max pour passer Maximal belastbarkeit pro Loch Carga maxima per centro	 660  760  734  834	9 Kg 11 Kg 13 Kg 16 Kg	Istruzioni di montaggio Assembling instructions Notice de montage Montageanleitung Manual de montaje			
	 	KCM660..TFBOM KCM760..TFBOM CG734..FBM2OM CG834..FBM2OM					
	 20 min	 1					
	<p>PRIMA DI COMINCIARE, VEDERE I CONSIGLI DI MONTAGGIO</p> <p>BEFORE STARTING, REFER TO THE ASSEMBLING ADVICE IN ANNEX.</p> <p>AVANT DE COMMENCER SE REPORTER AUX CONSEILS DE MONTAGE EN ANNEXE.</p> <p>VOR DIE MONTAGE, BITTE BEACHTENDE ANWEISUNGEN FOLGEN.</p> <p>ANTES DE EMPEZAR CONSULTAR LOS CONSEJOS PARA EL MONTAJE.</p>						
							
 A x 2	 A1 x 2	 B x 2	 C x 2	 D x 2	 E x 1	 F x 1	 G x 1
 H x 5	 I x 2	 L x 1	 M x 2				

17/12/2012 cod. 4004115200 1/4

View this product online at <https://marathonhardware.com/pd/041-VGLQ734-VCH>

