

Magnetic Strike Plate for Push Hinge with Adjustable Depth



Part Number: SDP39XXG

Salice Magnetic Strike Plate for Push Hinge

Compatible Hinges ----- Salice Push

Product Description

This retaining catch is magnetic and together with the magnetism of the push device, will considerably increase (about 30%) the holding strength of the door against the cabinet side, thus avoiding accidental openings. This catch is ideal for larger and heavier doors. Featuring 3mm of depth adjustment, this catch enables alignment between the door and the push device which can compensate for any slight warping or bowing of your door.

Product Advantages

- Adjustment of Depth from -0.5mm to +2.5mm
- Provides for perfect alignment with cabinet door

Product Application

To install, drill a hole of diameter 15 mm and 11 mm depth into the cabinet door at the point where your recessed push device is inserted into the side panel.



Technical Documents

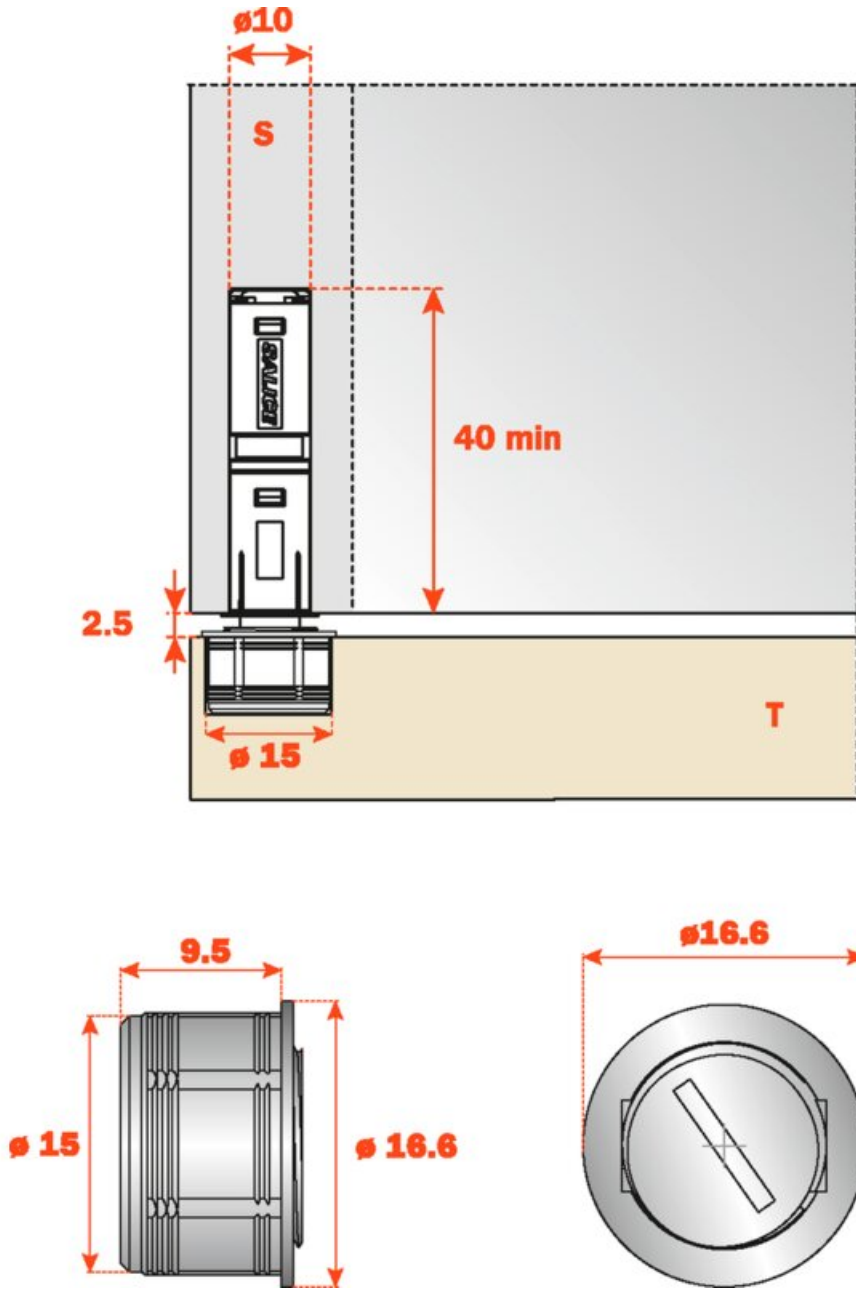

View this product online at <https://marathonhardware.com/pd/SDP39XXG>

Technical Documents

Adjustment -0.5 mm

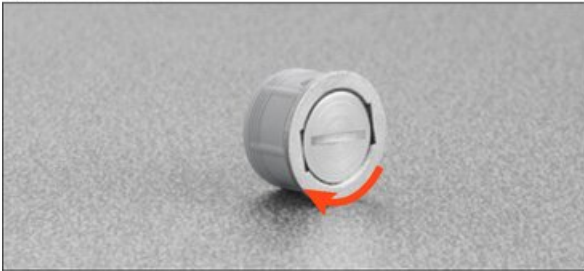

Adjustment +2.5 mm



View this product online at <https://marathonhardware.com/pd/SDP39XXG>



Technical Documents

Retaining catch application



3 - Magnetic retaining catch to be inserted

The retaining catch DP39 is itself magnetic and together with the magnetism of the release device DPM considerably increase (30%) the holding strength of the door against the cabinet side, thus avoiding accidental openings.

For the installation it is necessary to drill a hole $\varnothing 15$ mm and 11 mm depth in the door.

Depth adjustment from: -0.5 mm to +2.5 mm.

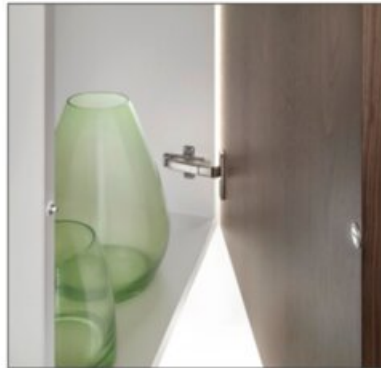
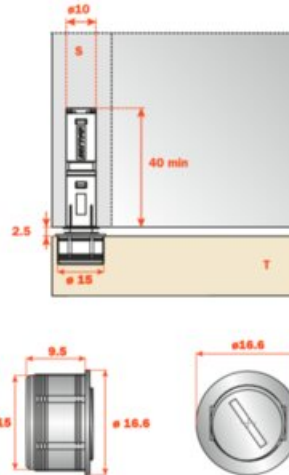

Adjustment -0.5 mm



Adjustment +2.5 mm

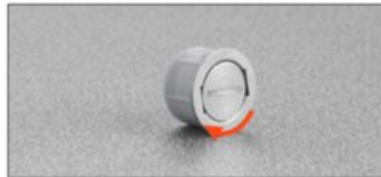

SALICE 201

View this product online at <https://marathonhardware.com/pd/SDP39XXG>



Technical Documents

Magnetic Push - Magnetic release device application

Application of the release device to be recessed

Drill a hole \varnothing 10 mm and min. 40 mm depth in the top, the side or the base panel of the cabinet.
Insert the release device into the hole.

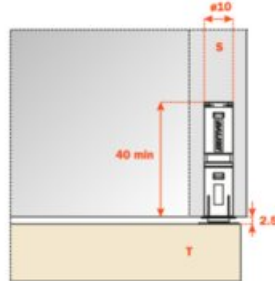

Release device application with adapter (DP82SN_R).

Insert the release device frontally into the adapter.
Place the adapter to the top, the side or the base panel of the cabinet, using the drilling value of 8+16 mm for final positioning.

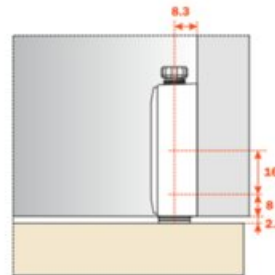

Release device application with spacer for inset doors (DP82SN_R + SP44XX_).

For inset doors it is essential to use the spacer SP44XX_.

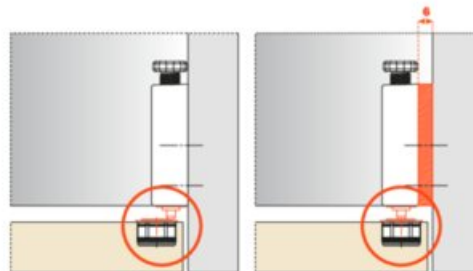



Technical Documents

Magnetic Push - Magnetic release devices and retaining catches

DPMSNB - beige



DPMSNG - grey



Release device.
ø 10 mm, 40 mm length.

Packing
Boxes 250 pcs.
Cartons 1.500 pcs.

DPASNB - beige



DPASNG - grey



Optional supplementary release device to increase the magnetic holding strength. It must always be used together with the DPM. The suggested position of the DPA is the point of pressure on the door. The DPA can be positioned at any point along the opening edge of the door. ø 10 mm, 40 mm length.

Packing
Boxes 250 pcs.
Cartons 1.500 pcs.

DP28SN9



Retaining catch to be inserted.
ø 11.5 mm.

Packing
Boxes 250 pcs.

DP38XX91



Retaining catch with adhesive.
20x14 mm.

Packing
Boxes 250 pcs.

DP39XXG

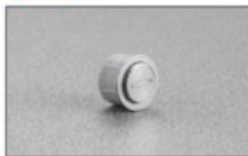

Adjustable magnetic retaining catch.
ø16.6 mm

Packing
Boxes 250 pcs.

SP44XX_



Spacer for inset door to be used together with DP82XX_R.

SP44XXG = grey
SP44XXB = beige

Packing
Boxes 250 pcs.

View this product online at <https://marathonhardware.com/pd/SDP39XXG>

