

Luca Knurled Pull 640mm Natural Brass

Part Number: 8170-640-NBR



Luca Knurled Designer Pull, 640mm, Natural Brass

Luca by Citterio Giulio, is a beautifully finished handle with a refined knurled texture, which complements many design projects.

Center to Center Length	640 mm
Collection	Luca
Colour Group	Gold
Finish Code	Natural Brass
Mounting Type	M4 Machine Screw
Overall Length	690 mm
Projection (Height)	31 mm
Style Family	Designer
Width	18 mm

Product Description

Luca is that stylish and sophisticated friend that drops in for a drink, or shares stories around the dinner table. Always polished, confident and composed, the Luca handle, much like the person, stands out in your memory as something distinctively special, warm, and welcome in your home.

Product Advantages

- Knurled texture
- 8 finishes and combinations to choose from
- 3 lengths: 160mm, 320mm, 640mm



Technical Documents

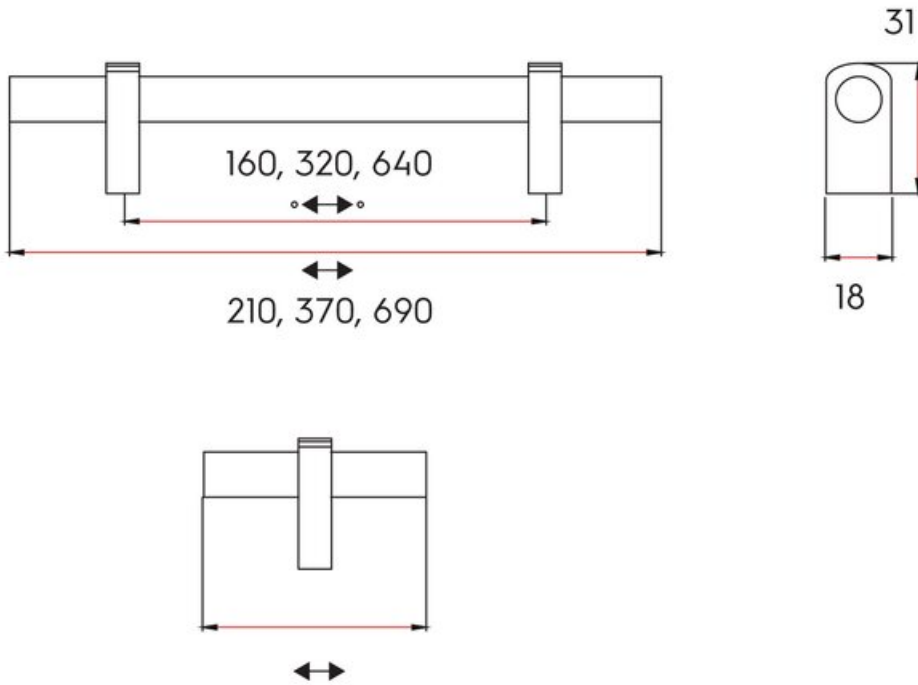

View this product online at <https://marathonhardware.com/pd/8170-640-NBR>

