

Luca Knurled Pull 160mm Natural Brass



Part Number: 8170-160-NBR

Luca Knurled Designer Pull, 160mm, Natural Brass

Luca by Citterio Giulio, is a beautifully finished handle with a refined knurled texture, which complements many design projects.

| | |
|-------------------------|------------------|
| Center to Center Length | 160 mm |
| Collection | Luca |
| Colour Group | Gold |
| Finish Code | Natural Brass |
| Mounting Type | M4 Machine Screw |
| Overall Length | 210 mm |
| Projection (Height) | 31 mm |
| Style Family | Designer |
| Width | 18 mm |

Product Description

Luca is that stylish and sophisticated friend that drops in for a drink, or shares stories around the dinner table. Always polished, confident and composed, the Luca handle, much like the person, stands out in your memory as something distinctively special, warm, and welcome in your home.

Product Advantages

- Knurled texture
- 8 finishes and combinations to choose from
- 3 lengths: 160mm, 320mm, 640mm



Technical Documents

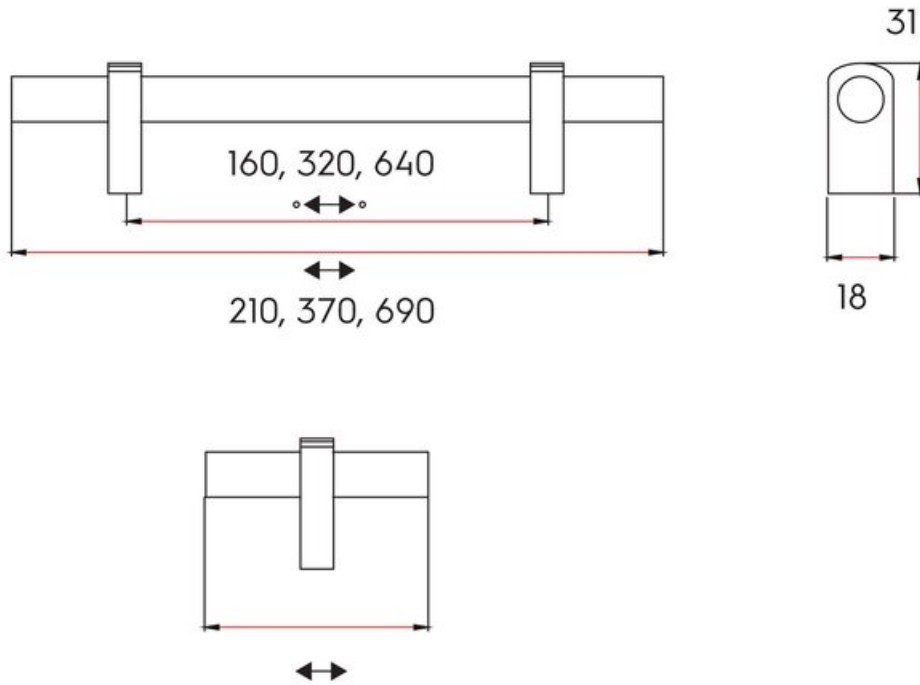

View this product online at <https://marathonhardware.com/pd/8170-160-NBR>

