

Luca Knurled Pull 160mm Matte Black



Part Number: 8170-160-DBK

Luca Knurled Designer Pull, 160mm, Matte Black

Luca by Citterio Giulio, is a beautifully finished handle with a refined knurled texture, which complements many design projects.

Center to Center Length	160 mm
Collection	Luca
Colour Group	Black
Finish Code	Matte Black
Mounting Type	M4 Machine Screw
Overall Length	210 mm
Projection (Height)	31 mm
Style Family	Designer
Width	18 mm

Product Description

Luca is that stylish and sophisticated friend that drops in for a drink, or shares stories around the dinner table. Always polished, confident and composed, the Luca handle, much like the person, stands out in your memory as something distinctively special, warm, and welcome in your home.

Product Advantages

- Knurled texture
- 8 finishes and combinations to choose from
- 3 lengths: 160mm, 320mm, 640mm



Technical Documents

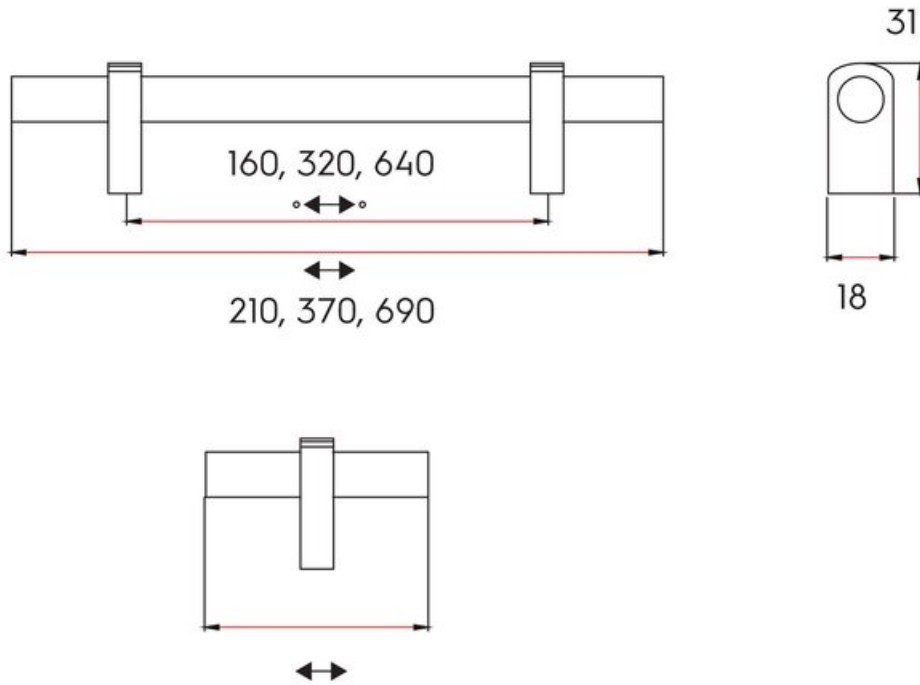

View this product online at <https://marathonhardware.com/pd/8170-160-DBK>

